

ALU-RACK KAWASAKI Z 750 / Z 1000 '07  
ALU-RACK KAWASAKI Z 750 / Z 1000 '07

**Montagehinweise**

Alle vom Motorrad gelösten Schrauben sind gemäß Herstellerangaben wieder zu montieren, oder mit von SW-MOTECH gelieferten Schrauben zu ersetzen. Falls nicht anderweitig definiert, diese Schrauben nach Tabelle anziehen:

M6	9,6 Nm
M8	23 Nm

Gegebenenfalls Schrauben mit flüssiger Schraubensicherung einkleben.

Prüfen Sie nach 50 km alle Verbindungen auf festen Sitz.

**Max. Zuladung 5 Kg inklusive Koffer und Adapter.  
Ist das Zuladungsgewicht des Fahrzeuges durch den Hersteller limitiert, gelten diese Grenzwerte.**

**Mounting Instruction**

SW-MOTECH products should be installed by a qualified, experienced motorcycle technician. If you are unsure of your ability to properly install a product, please have the product installed by your local motorcycle dealer. SW-MOTECH takes no responsibility for damages caused by improper installation.

All screws, bolts and nuts, including all replacement hardware provided by SW-MOTECH, should be tightened to the torque specified in the OEM maintenance manual for your motorcycle. If no torque specifications are provided in the OEM maintenance manual, the following torques may be used:

M6	9,6 Nm
M8	23 Nm

All screws, bolts and nuts should be checked after driving the first 50 km to ensure that all are tightened to the proper torque.









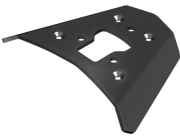

Medium strength liquid thread-locker (i.e., "Loctite") should be used to secure all screws, bolts and nuts.

**Max. Load On Rear Carrier: 5 Kg (11 lbs) inclusive case and adapter or the motorcycle manufacturer's weight limit, whichever is less.**

SW-MOTECH GmbH & Co. KG  
Ernteweg 8/10  
35282 Rauschenberg  
Germany

Tel. +49 (0) 64 25/8 16 8-00  
Fax +49 (0) 64 25/8 16 8-10

info@sw-motech.com  
www.sw-motech.com

<p>1 ALU-RACK ALU-RACK</p>  <p>schwarz/black</p> <p>GPT.o8.385.001 00</p> <p>Anzahl/ Pcs. 1</p>	<p>2 Unterbau Base Frame</p>  <p>GPT.o8.385.921/922 00</p> <p>Anzahl/ Pcs. 2 (L/R)</p>	<p>6 Querverbinder Cross Girder</p>  <p>GPT.o8.385.923 00</p> <p>Anzahl/ Pcs. 1</p>	<p>10 Winkelblech Angle Lug</p>  <p>GPT.o8.385.003 00</p> <p>Anzahl/ Pcs. 1</p>
<p>3 Senkkopfschraube Counter Sunk Screw</p>  <p>schwarz/black</p> <p>M8 x 20 DIN 7991</p> <p>Anzahl/ Pcs. 4</p>	<p>7 Sechskantschraube Hexagon Screw</p>  <p>silber/silver</p> <p>M6 x 80 DIN 933</p> <p>Anzahl/ Pcs. 2</p>	<p>11 Distanzbuchse Spacer</p>  <p>Da:14 Di:8,4 h:40</p> <p>Anzahl/ Pcs. 2</p>	
<p>4 Mutter mit Bund, selbstsichernd Lock Nut with Flange</p>  <p>schwarz/black</p> <p>M8 DIN 6927</p> <p>Anzahl/ Pcs. 4</p>	<p>8 Linsenkopfschraube Lenshead Screw</p>  <p>schwarz/black</p> <p>M8 x 20 ISO 7380</p> <p>Anzahl/ Pcs. 2</p>		
<p>5 Rohrendstopfen Plastic Cap</p>  <p>schwarz/black</p> <p>KES.RD.210.0300.02.GL</p> <p>Anzahl/ Pcs. 2</p>	<p>9 Unterlegscheibe Washer</p>  <p>silber/silver</p> <p>A 6,4 DIN 125</p> <p>Anzahl/ Pcs. 2</p>		



**1** Sozius-Sitz entfernen, original Winkelblech demontieren und durch Winkelblech (10) ersetzen. Zur Montage die original Schrauben verwenden.  
 Remove sozius-seat, detach original angle lug and attach angle lug (10) with the original screws.

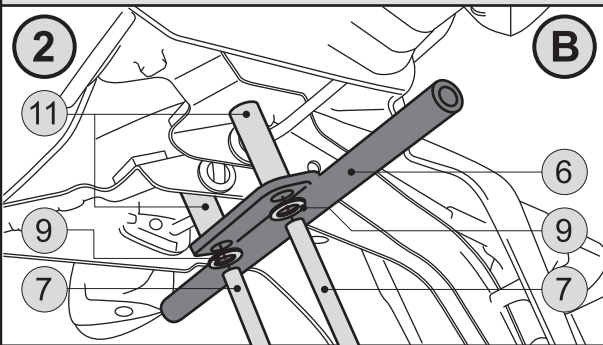

**2** Verschrauben Sie den Querverbinder (6) mit Distanzbuchse (11), Schraube (7) und Unterlegscheibe (9) wie gezeigt.  
 Attach cross girder (6) with spacer (11), screw (7) and washer (9) as shown.



**3** Schraube (7) mit original Mutter befestigen.  
 Attach screw (7) with original nut.

**!** Achtung: Falls die Montage einer Adapterplatte vorgesehen ist, MÜSSEN die Haltenocken am ALU-RACK vor dessen Anbau am Motorrad verschraubt werden.  
 Attention: Cam-locks from adapter kit MUST be installed before attaching the ALU-RACK to the bike.

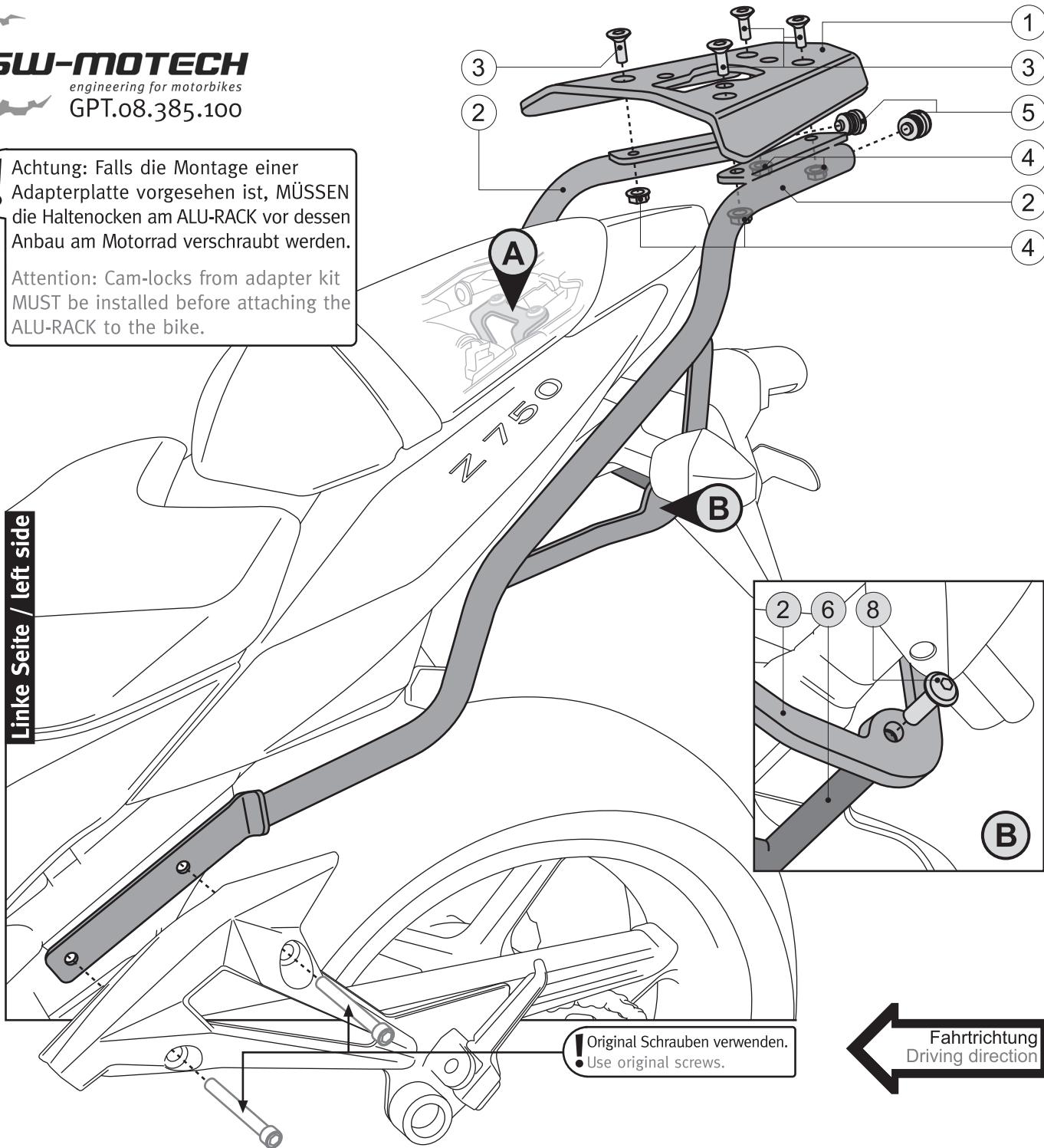

Linke Seite / left side

**!** Original Schrauben verwenden.  
 Use original screws.

← Fahrtrichtung  
 Driving direction